

## #6030 SLIDING DOOR SYSTEM

Legacy's patent pending automatic door bottom for the sliding door application has a unique low force activation mechanism which allows for more successful operations.

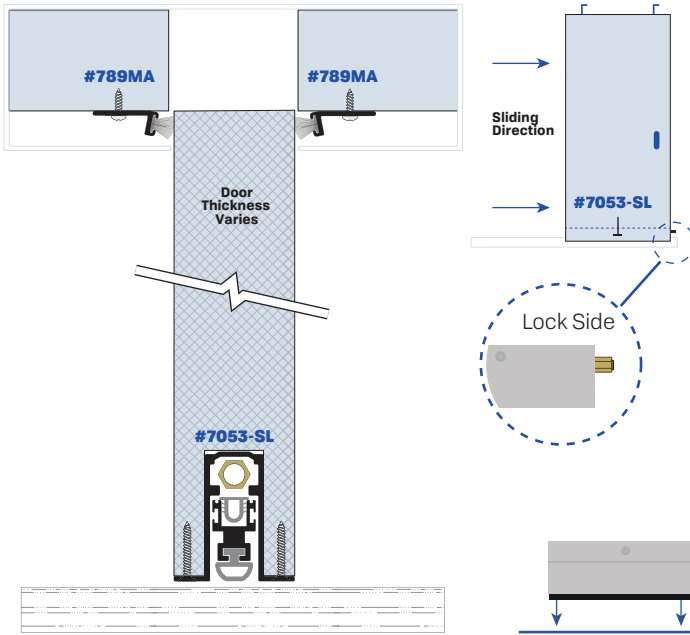

Even drop for sliding doors

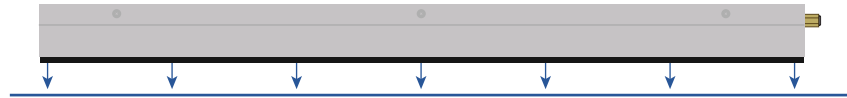

## #6040 POCKET LATCH SYSTEM

Legacy's patent pending automatic door bottom for the pocket latch application has a unique low force activation mechanism which allows for more successful operations.

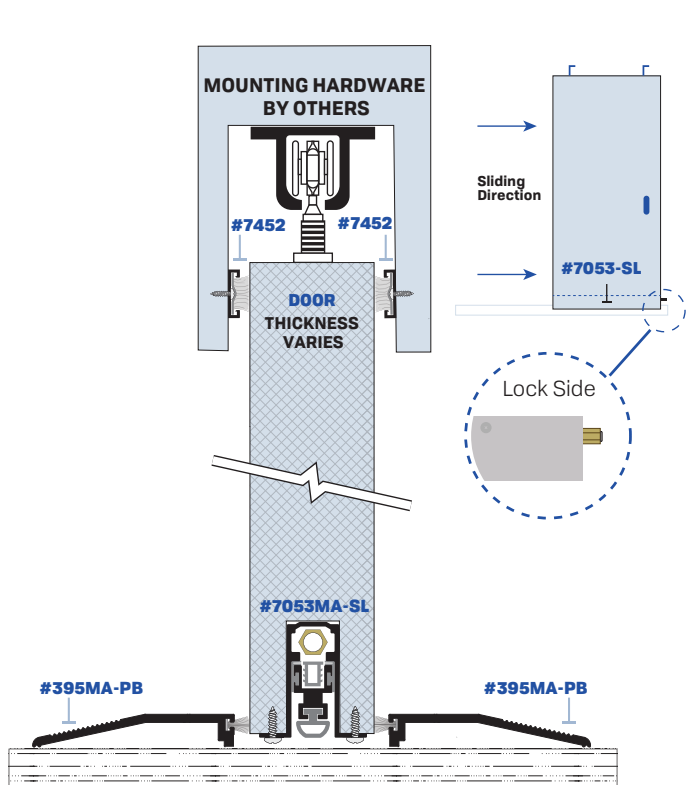

### #7452

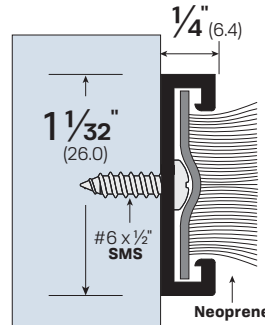

### #7053-SL

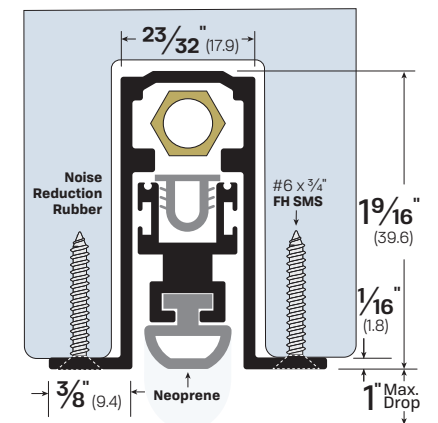

### #395-PB

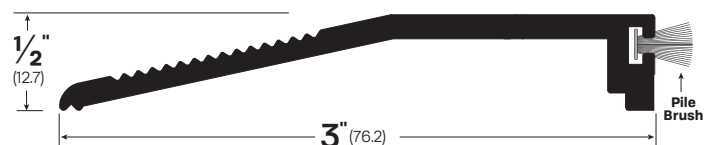

Specialty Solutions